

# HL8500H

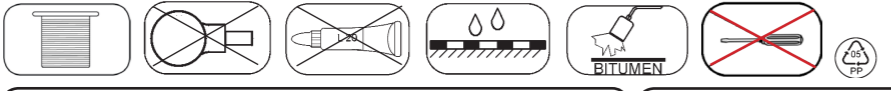

HL151



HL01093D

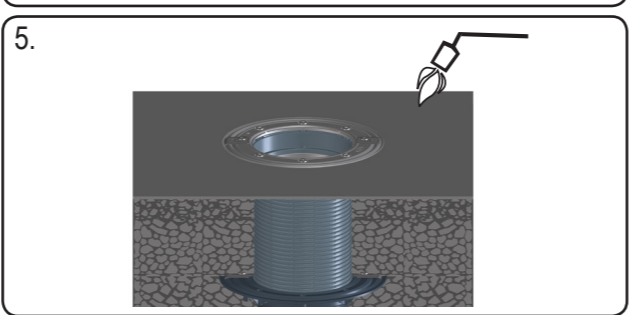
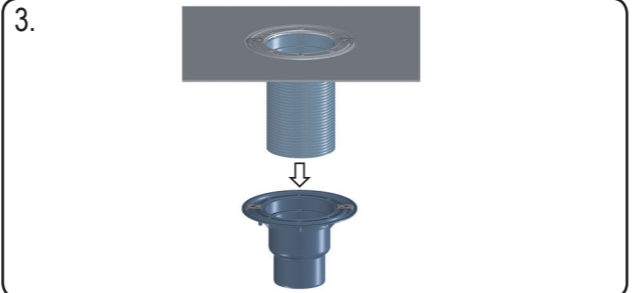
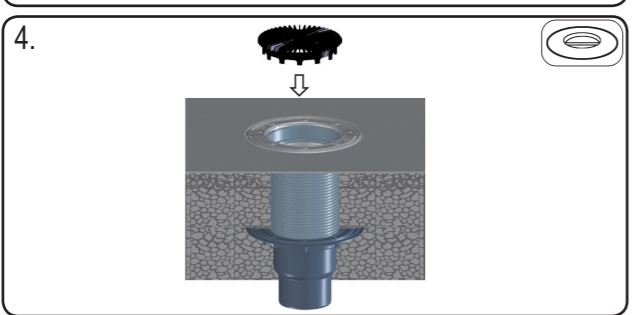
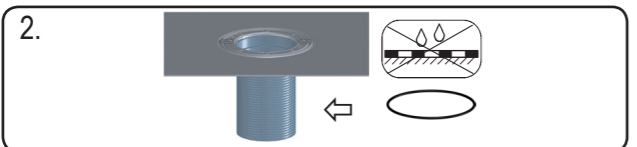
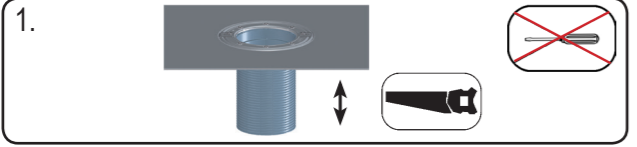
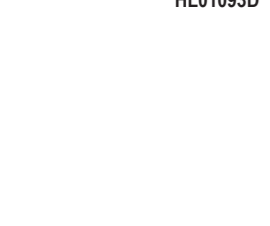

**D** AUFSTOCKELEMENT M. FLANSCH **TR** FLANŞLI YÜKSELTME PARÇASI **H** MAGASÍTÓELEM SZIGETELŐ GALLÉRRAL **RO** ROELEMENT DE ÎNĂLȚARE CU FLANȘĂ **PL** NASADKA Z KOLNIERZEM **SLO** CEVNI PODALJŠEK S PRIROBNICO **31.07.2017**  
**I** PROLUNGA CON FLANGIA **CZ/SK** NÁSTAVEC S PEVNOU IZOLAČNÍ PŘÍRUBOU **PL** NASADKA Z KOLNIERZEM **RO** ROELEMENT DE ÎNĂLȚARE CU FLANȘĂ **PL** NASADKA Z KOLNIERZEM **SLO** CEVNI PODALJŠEK S PRIROBNICO **BUL** НАСТАВКА С ФЛАНЦЕМ  
**GB** EXTENTION WITH GLANGE **HR** NASTAVNI ELEMENT S BRTVENOM PRIRUBNICOM **SLO** CEVNI PODALJŠEK S PRIROBNICO **BUL** НАСТАВКА С ФЛАНЦЕМ

# HL8500H

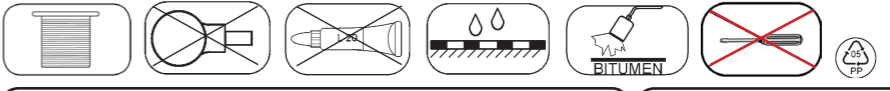

HL151

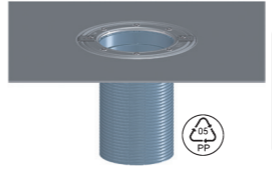

HL01093D

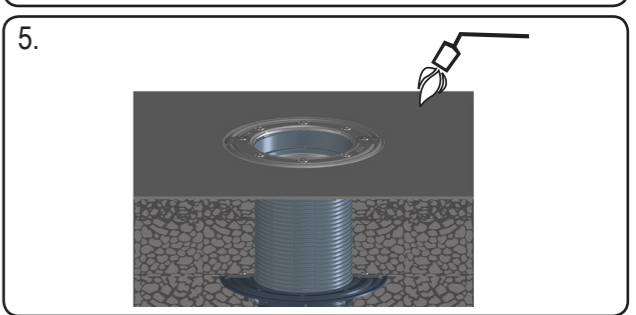
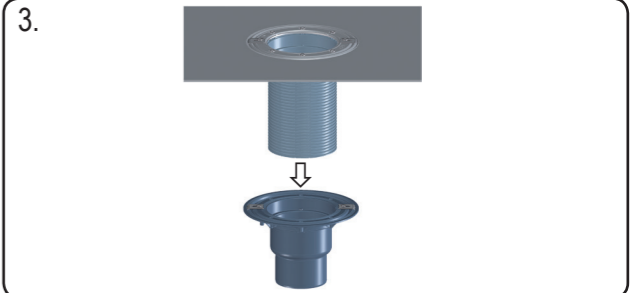
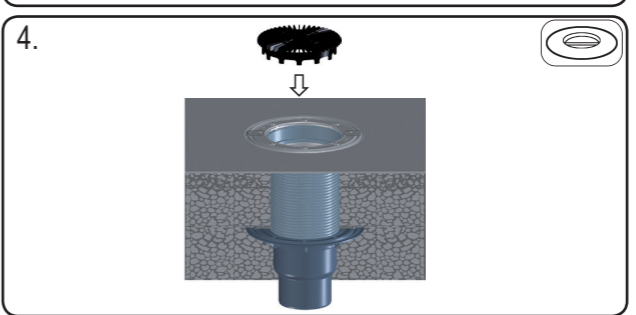
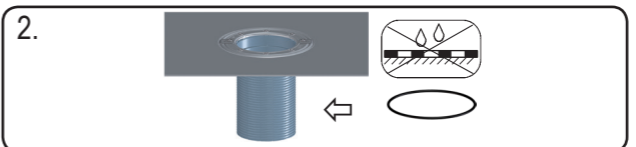
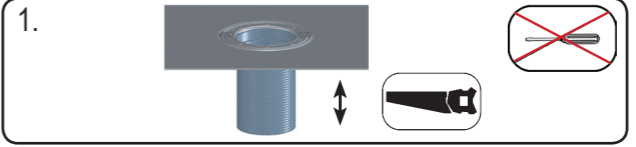
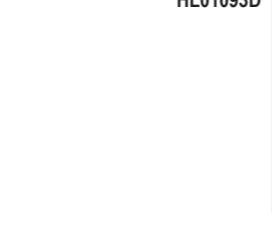

**D** AUFSTOCKELEMENT M. FLANSCH **TR** FLANŞLI YÜKSELTME PARÇASI **H** MAGASÍTÓELEM SZIGETELŐ GALLÉRRAL **RO** ROELEMENT DE ÎNĂLȚARE CU FLANȘĂ **PL** NASADKA Z KOLNIERZEM **SLO** CEVNI PODALJŠEK S PRIROBNICO **31.07.2017**  
**I** PROLUNGA CON FLANGIA **CZ/SK** NÁSTAVEC S PEVNOU IZOLAČNÍ PŘÍRUBOU **PL** NASADKA Z KOLNIERZEM **RO** ROELEMENT DE ÎNĂLȚARE CU FLANȘĂ **PL** NASADKA Z KOLNIERZEM **SLO** CEVNI PODALJŠEK S PRIROBNICO **BUL** НАСТАВКА С ФЛАНЦЕМ  
**GB** EXTENTION WITH GLANGE **HR** NASTAVNI ELEMENT S BRTVENOM PRIRUBNICOM **SLO** CEVNI PODALJŠEK S PRIROBNICO **BUL** НАСТАВКА С ФЛАНЦЕМ

# HL8500H

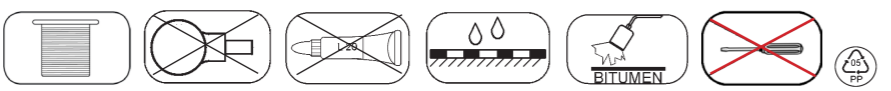

HL151

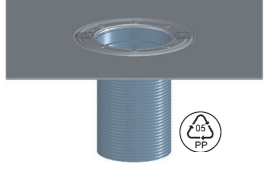

HL01093D

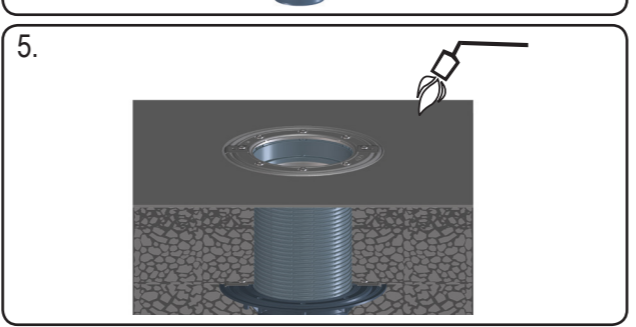
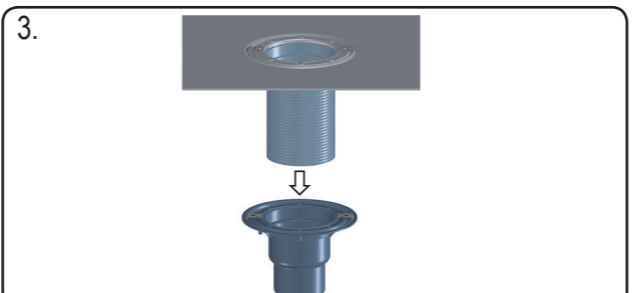
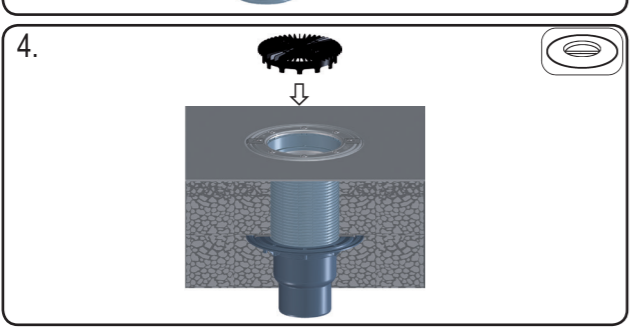
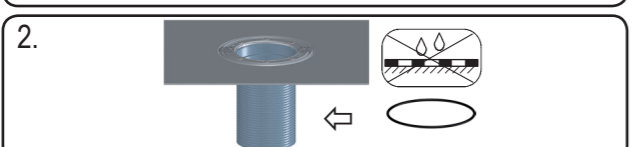
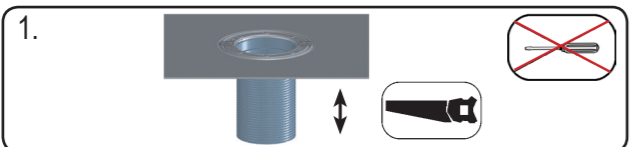

**D** AUFSTOCKELEMENT M. FLANSCH **TR** FLANŞLI YÜKSELTME PARÇASI **H** MAGASÍTÓELEM SZIGETELŐ GALLÉRRAL **RO** ROELEMENT DE ÎNĂLȚARE CU FLANȘĂ **PL** NASADKA Z KOLNIERZEM **SLO** CEVNI PODALJŠEK S PRIROBNICO **31.07.2017**  
**I** PROLUNGA CON FLANGIA **CZ/SK** NÁSTAVEC S PEVNOU IZOLAČNÍ PŘÍRUBOU **PL** NASADKA Z KOLNIERZEM **RO** ROELEMENT DE ÎNĂLȚARE CU FLANȘĂ **PL** NASADKA Z KOLNIERZEM **SLO** CEVNI PODALJŠEK S PRIROBNICO **BUL** НАСТАВКА С ФЛАНЦЕМ  
**GB** EXTENTION WITH GLANGE **HR** NASTAVNI ELEMENT S BRTVENOM PRIRUBNICOM **SLO** CEVNI PODALJŠEK S PRIROBNICO **BUL** НАСТАВКА С ФЛАНЦЕМ

# HL8500H

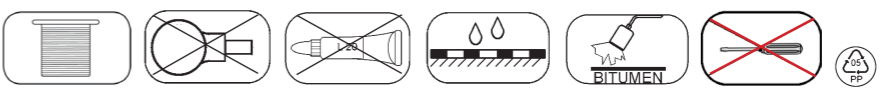

HL151

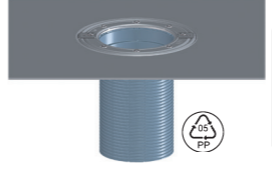

HL01093D

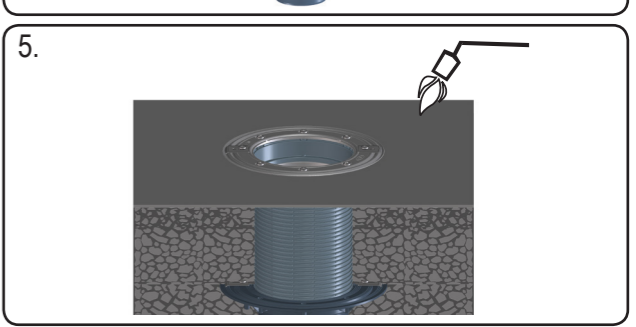
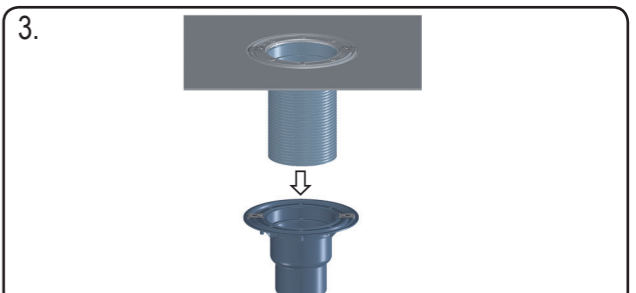
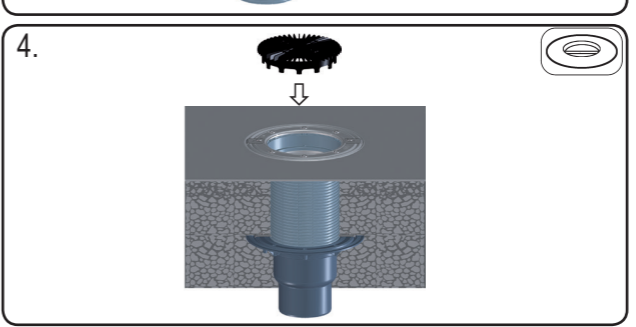
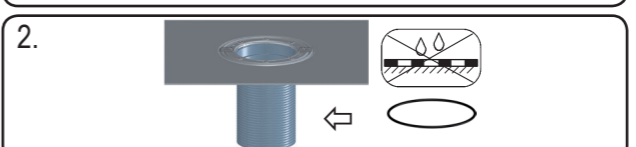
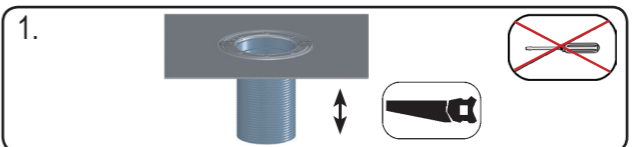

**D** AUFSTOCKELEMENT M. FLANSCH **TR** FLANŞLI YÜKSELTME PARÇASI **H** MAGASÍTÓELEM SZIGETELŐ GALLÉRRAL **RO** ROELEMENT DE ÎNĂLȚARE CU FLANȘĂ **PL** NASADKA Z KOLNIERZEM **SLO** CEVNI PODALJŠEK S PRIROBNICO **31.07.2017**  
**I** PROLUNGA CON FLANGIA **CZ/SK** NÁSTAVEC S PEVNOU IZOLAČNÍ PŘÍRUBOU **PL** NASADKA Z KOLNIERZEM **RO** ROELEMENT DE ÎNĂLȚARE CU FLANȘĂ **PL** NASADKA Z KOLNIERZEM **SLO** CEVNI PODALJŠEK S PRIROBNICO **BUL** НАСТАВКА С ФЛАНЦЕМ  
**GB** EXTENTION WITH GLANGE **HR** NASTAVNI ELEMENT S BRTVENOM PRIRUBNICOM **SLO** CEVNI PODALJŠEK S PRIROBNICO **BUL** НАСТАВКА С ФЛАНЦЕМ